

RAILS - 17000  
CASMA

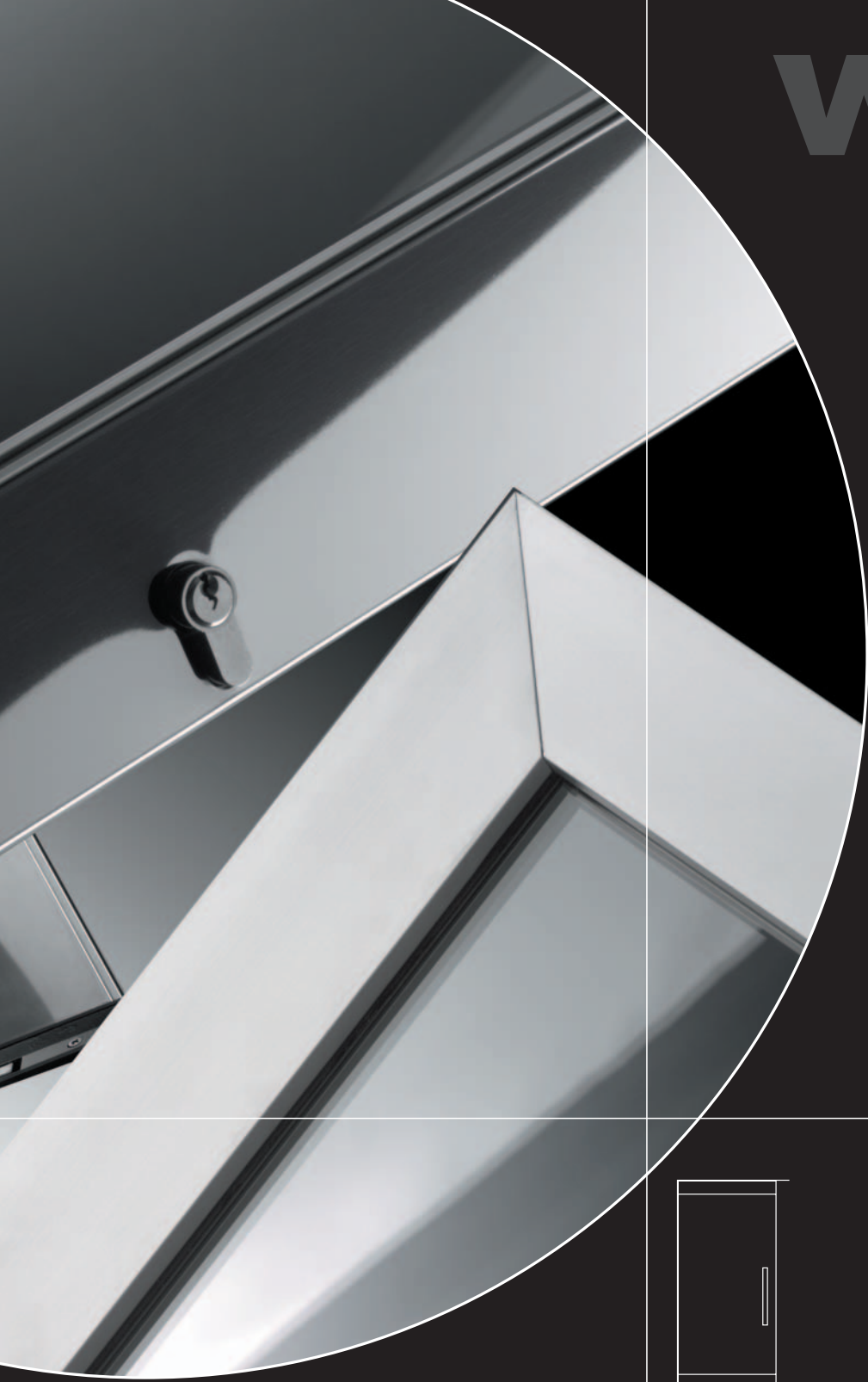

**Lavorazione  
del vetro**  
*Glass Fabrication*  
*Muecas en el vidrio*

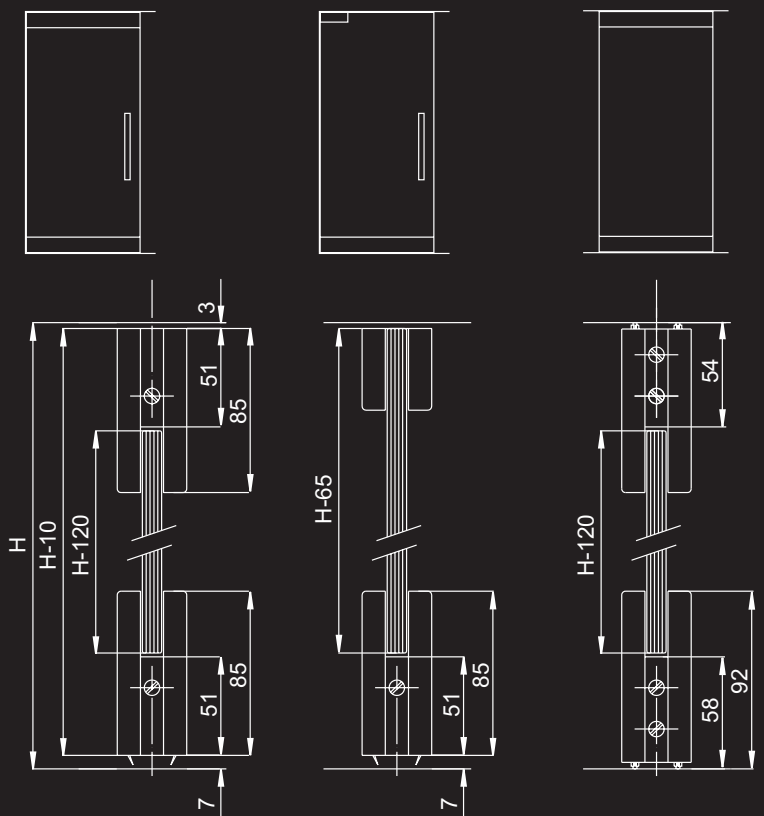

# 17100

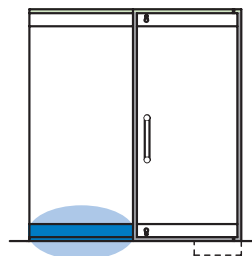

CASMA

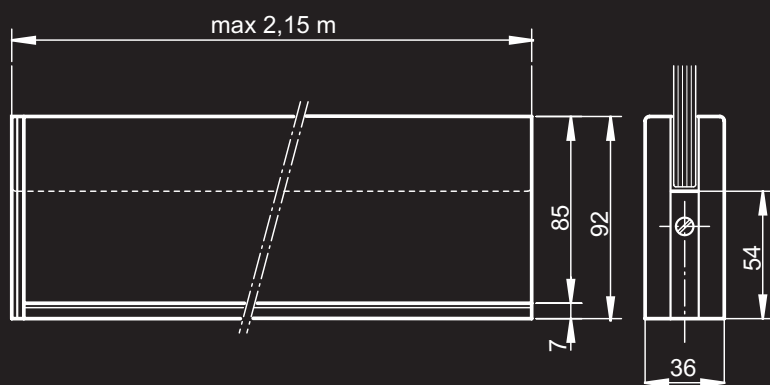
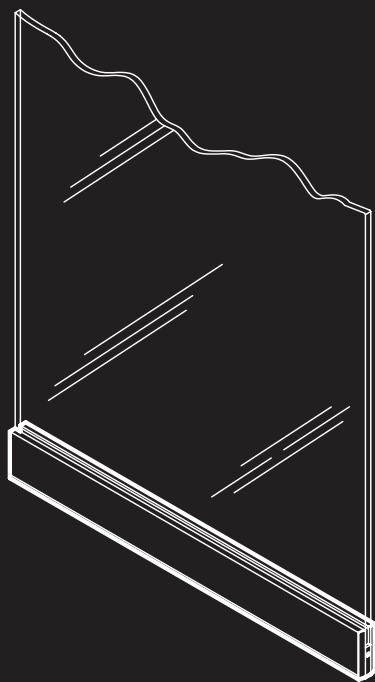
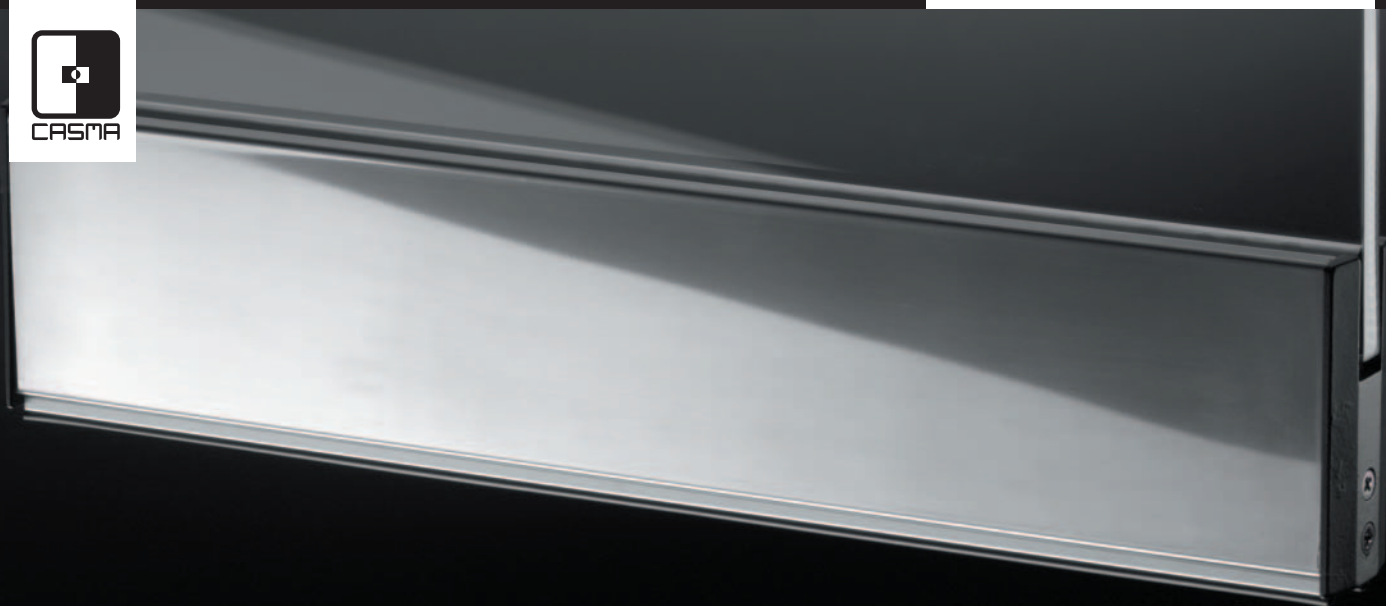

## Caratteristiche Tecniche

*Technical characteristics*

*Características técnicas*

**Spessore vetro** 8/10/12 mm

*Glass thickness*

*Espesor del vidrio*

**Finiture disponibili**

*Available finishes*

*Acabados disponibles*

610	
611	
610	
612	
613	
614	
615	
620	
632	
633	
Ral	
710	
711	
712	
713	
715	
810	
812	

# 17110

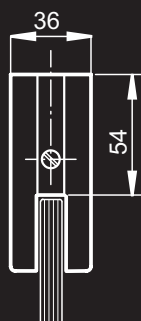
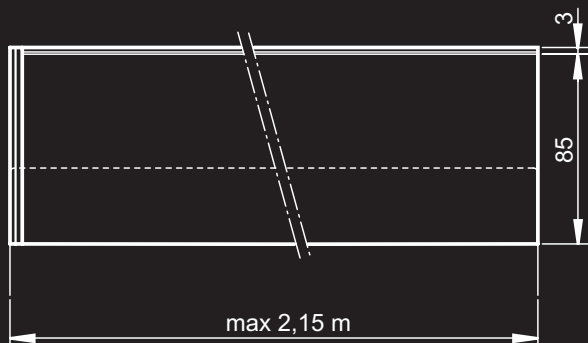
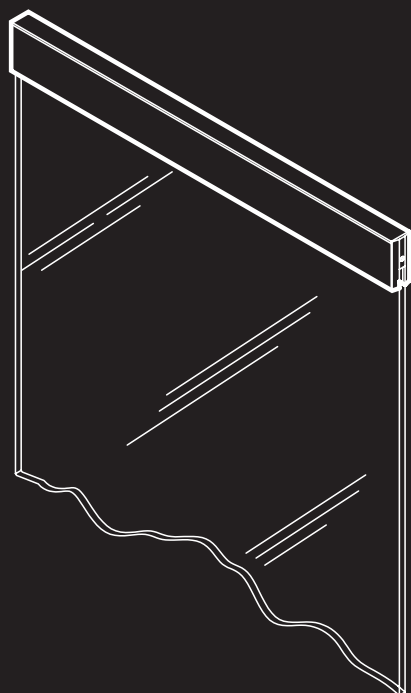
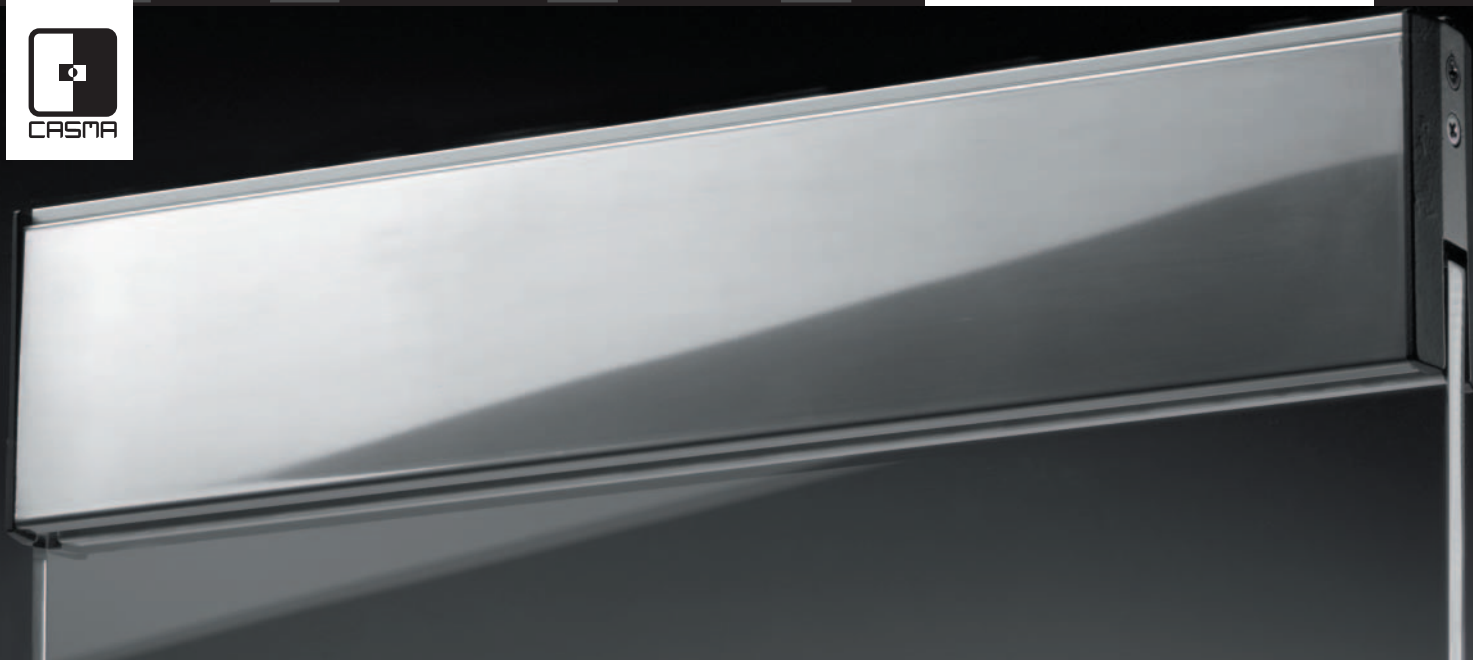
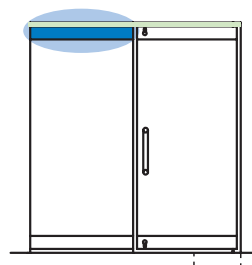

## Caratteristiche Tecniche

Technical characteristics

Características técnicas

**Spessore vetro** 8/10/12 mm

Glass thickness

Espesor del vidrio

## Finiture disponibili

Available finishes

Acabados disponibles

610	
611	
610	
612	
613	
614	
615	
620	
632	
633	
Ral	
710	
711	
712	
713	
715	
810	
812	

# 17200

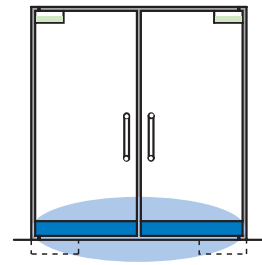

CASMA

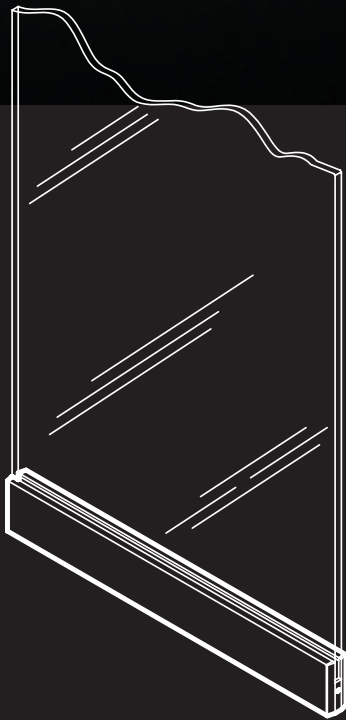
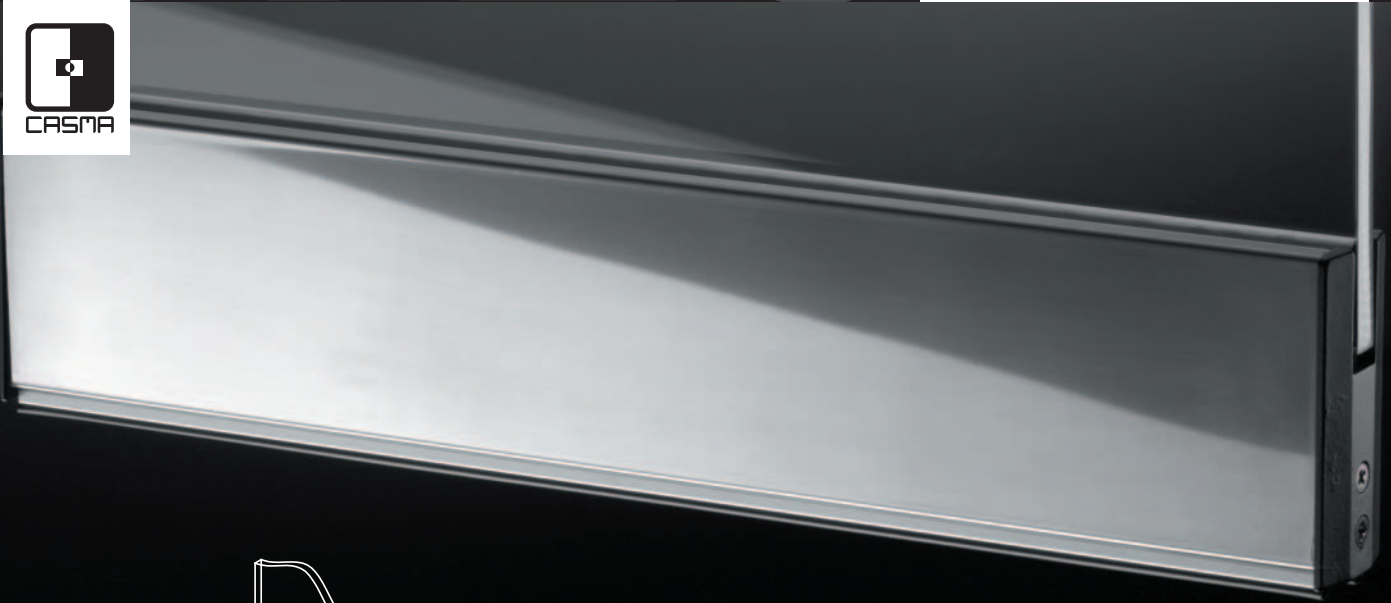

## Caratteristiche Tecniche

*Technical characteristics*

*Características técnicas*

**Spessore vetro** 8/10/12 mm

*Glass thickness*

*Espesor del vidrio*

**Peso max della porta** 120 Kg

*Max door weight*

*Peso máximo de la puerta*

**Larghezza max della porta** 1300 mm

*Max door width*

*Ancho máximo de la puerta*

**Coppia di serraggio** Nm 14÷16

**raccomandata per il fissaggio**

*Recommended torque for fixing screw*

*Momento del cerramiento*

*aconsejado para tornillos*

## Finiture disponibili

*Available finishes*

*Acabados disponibles*

610 —

611 —

610 —

612 —

613 —

614 —

615 —

620 —

632 —

633 —

Ral —

710 —

711 —

712 —

713 —

715 —

810 —

812 —

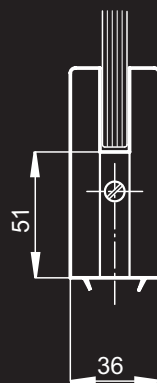
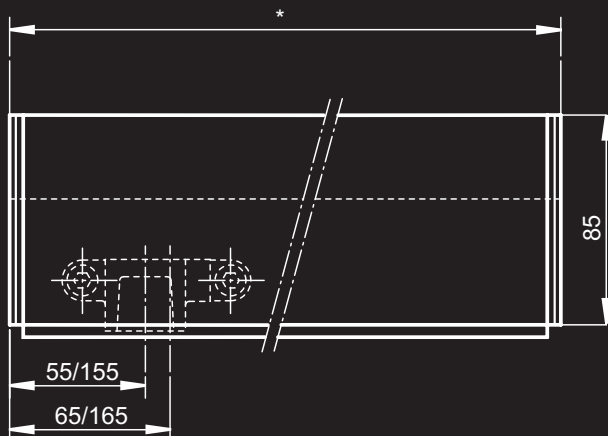

# 17270

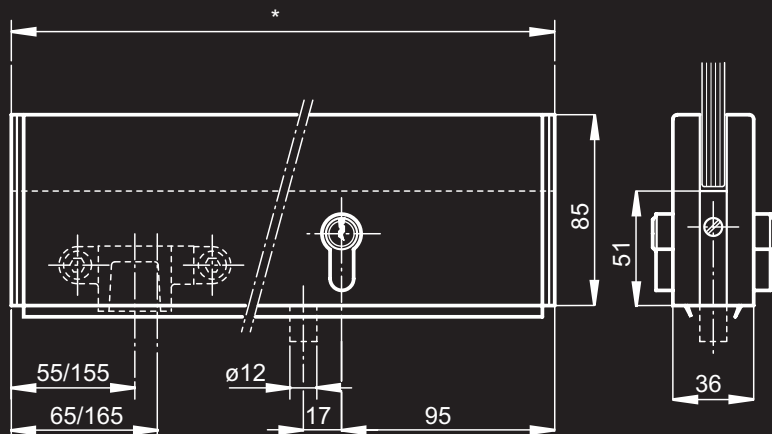
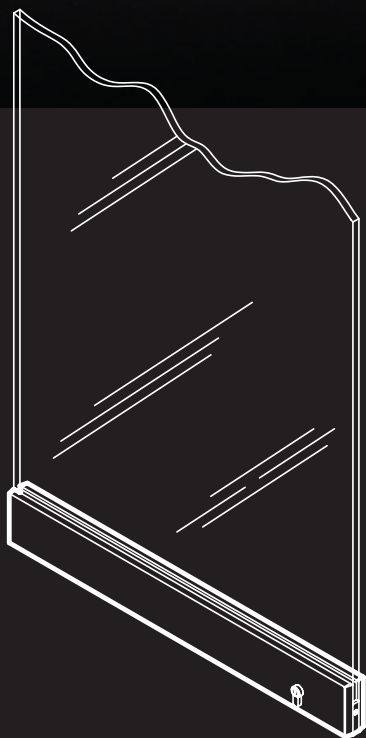
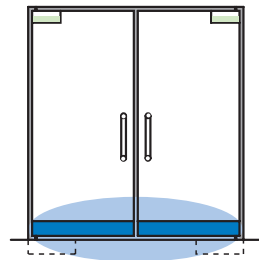

## Caratteristiche Tecniche

*Technical characteristics*

*Características técnicas*

**Spessore vetro** 8/10/12 mm

*Glass thickness*

*Espesor del vidrio*

**Peso max della porta** 120 Kg

*Max door weight*

*Peso máximo de la puerta*

**Larghezza max della porta** 1300 mm

*Max door width*

*Ancho máximo de la puerta*

**Coppia di serraggio** Nm 14÷16

**raccomandata per il fissaggio**

*Recommended torque for fixing screw*

*Momento del cerramiento aconsejado para tornillos*

## Finiture disponibili

*Available finishes*

*Acabados disponibles*

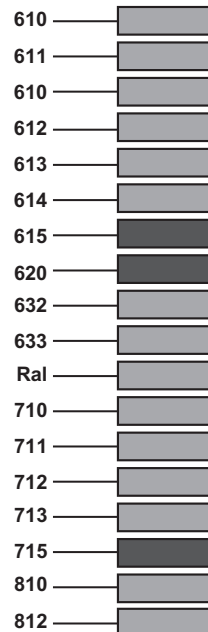

# 17300

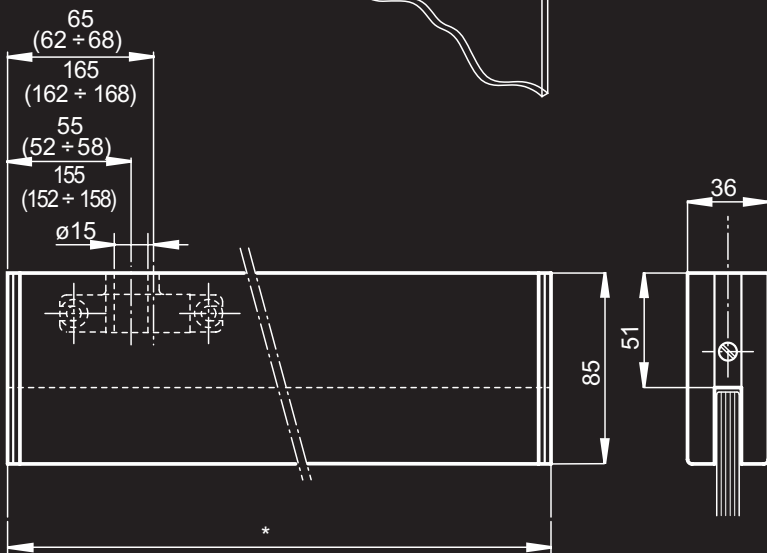
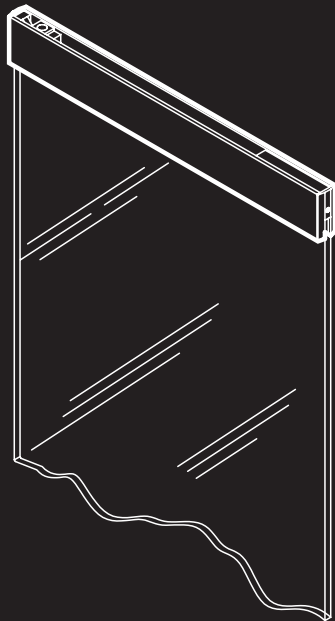
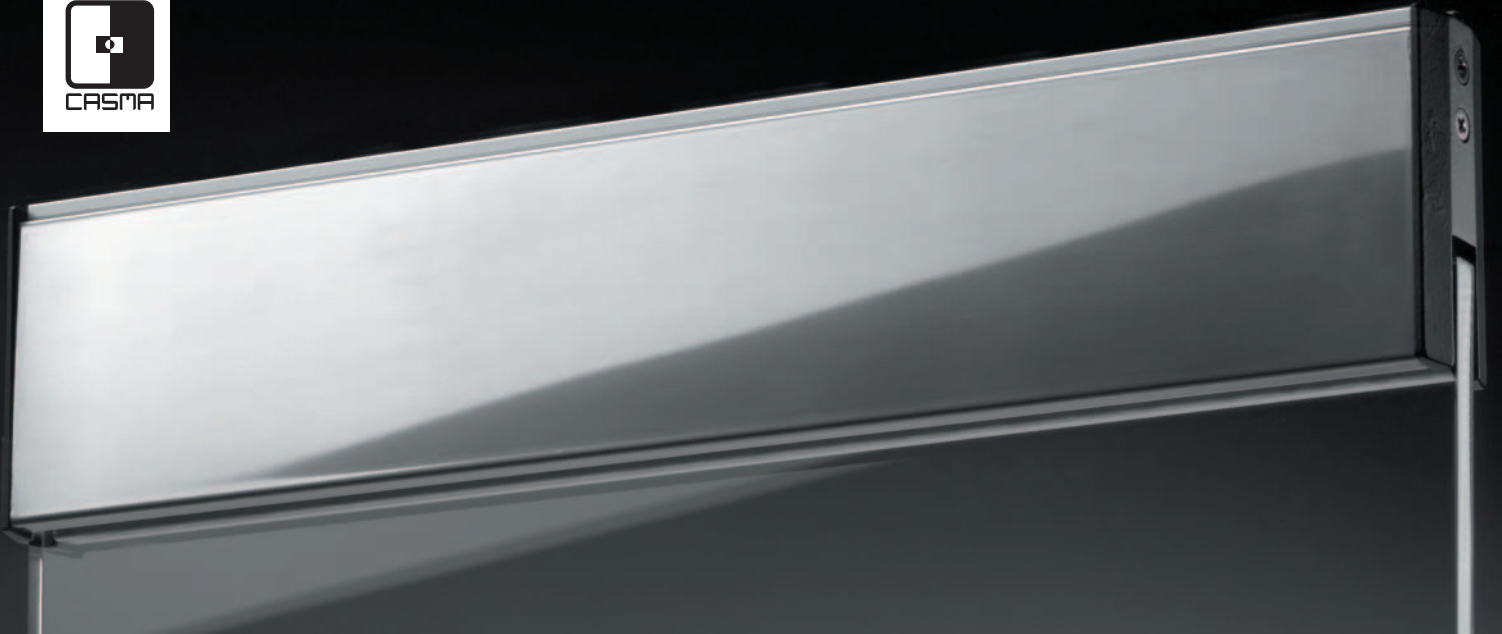
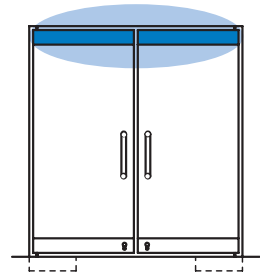

## Caratteristiche Tecniche

*Technical characteristics*

*Características técnicas*

**Spessore vetro** 8/10/12 mm

*Glass thickness*

*Espesor del vidrio*

**Peso max della porta** 120 Kg

*Max door weight*

*Peso máximo de la puerta*

**Larghezza max della porta** 1300 mm

*Max door width*

*Ancho máximo de la puerta*

**Coppia di serraggio** Nm 14÷16

**raccomandata per il fissaggio**

*Recommended torque for fixing screw*

*Momento del cerramiento aconsejado para tornillos*

## Finiture disponibili

*Available finishes*

*Acabados disponibles*

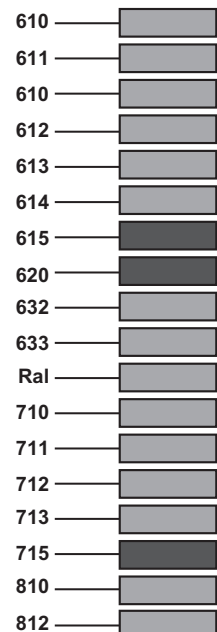

# 17370

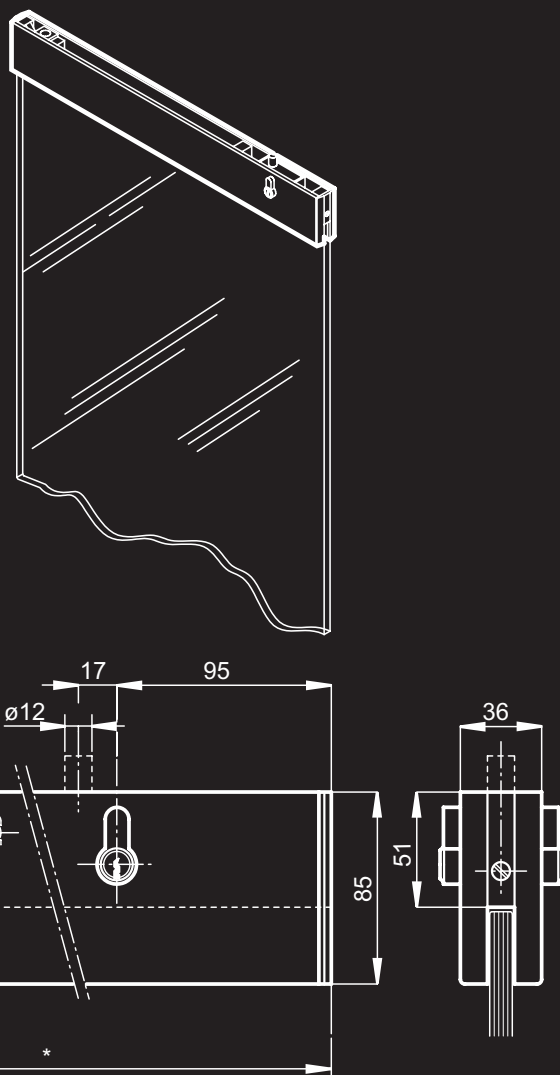
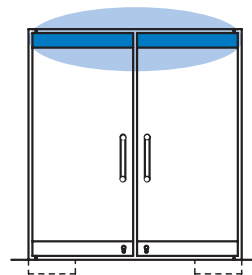

## Caratteristiche Tecniche

Technical characteristics  
Características técnicas

**Spessore vetro** 8/10/12 mm  
Glass thickness  
Espesor del vidrio

**Peso max della porta** 120 Kg  
Max door weight  
Peso máximo de la puerta

**Larghezza max della porta** 1300 mm  
Max door width  
Ancho máximo de la puerta

**Coppia di serraggio** Nm 14÷16  
**raccomandata per il fissaggio**  
Recommended torque for fixing screw  
Momento del cerramiento aconsejado para tornillos

**Finiture disponibili**  
Available finishes  
Acabados disponibles

- 610
- 611
- 610
- 612
- 613
- 614
- 615
- 620
- 632
- 633
- Ral
- 710
- 711
- 712
- 713
- 715
- 810
- 812